

PLAN

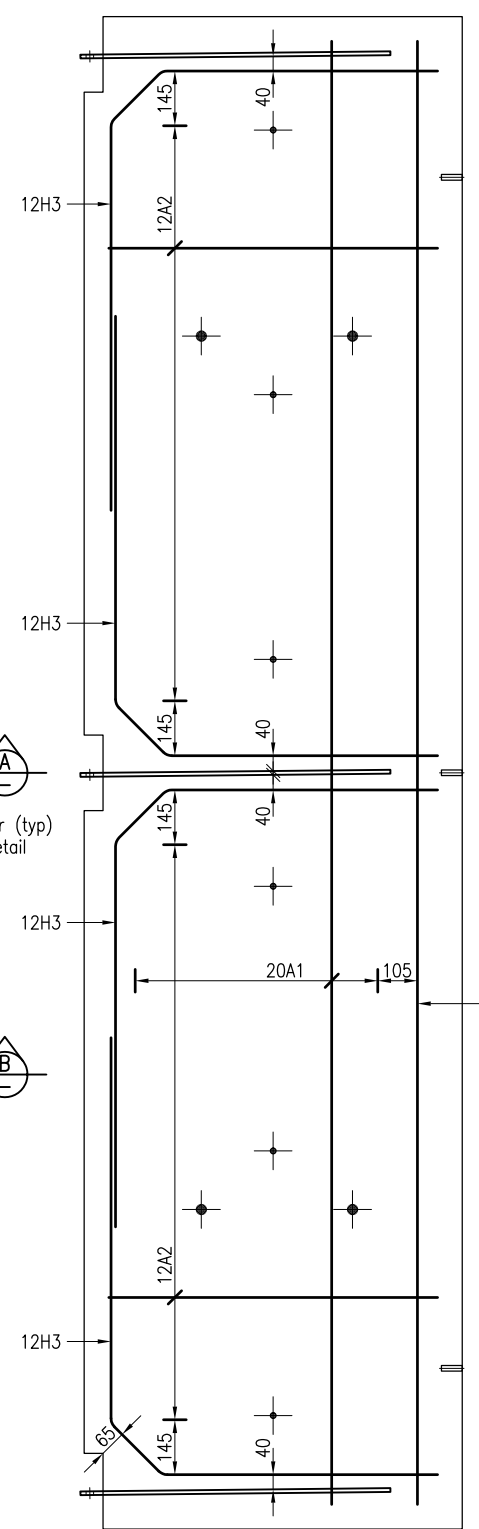

REINFORCEMENT PLAN

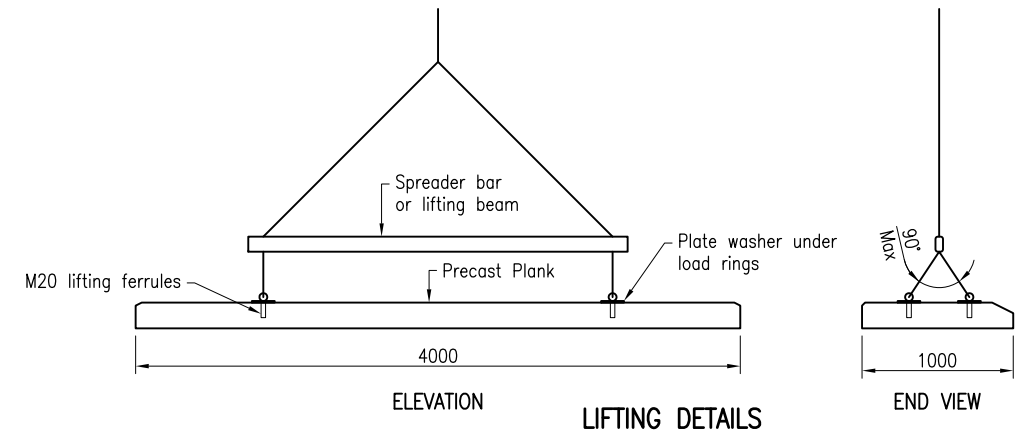

LIFTING DETAILS

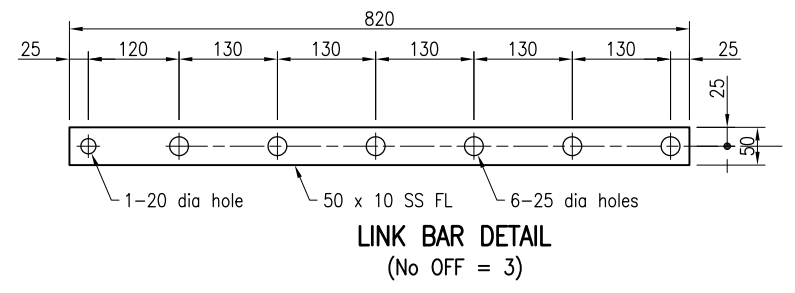

LINK BAR DETAIL
(No OFF = 3)

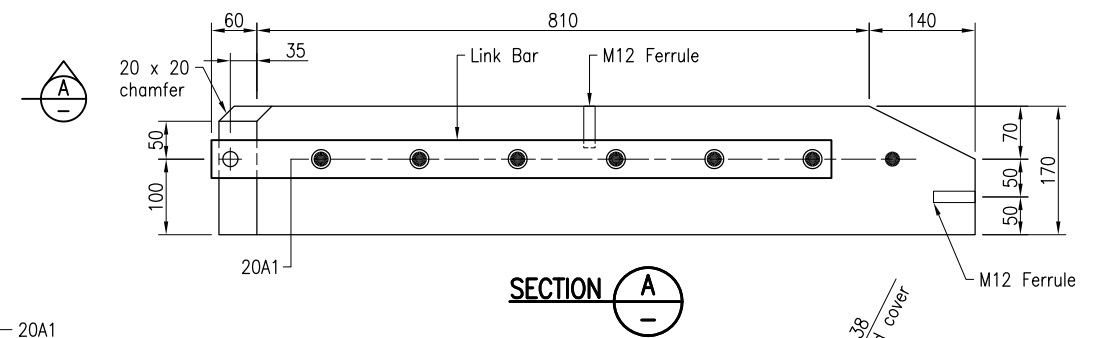

SECTION A

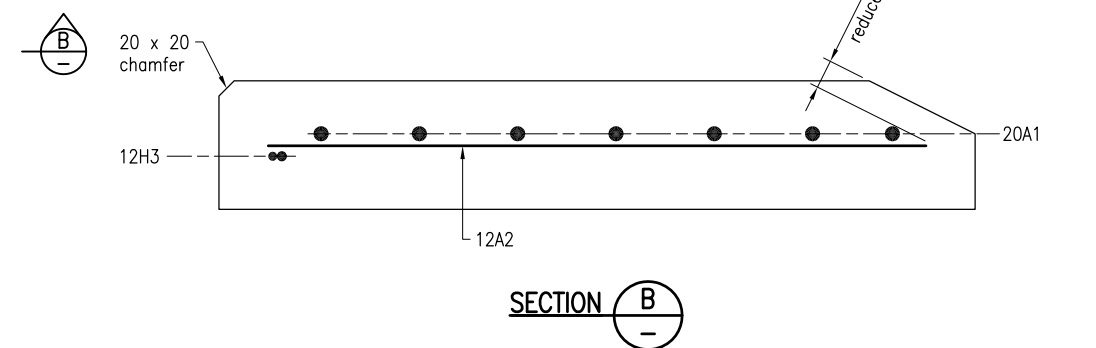

SECTION B

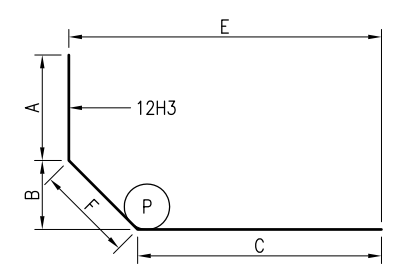

BAR DIMENSIONS

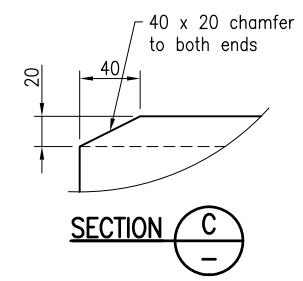

SECTION C

SCHEDULE

PLANK TYPE	DIMENSIONS		REINFORCEMENT										Length	Quantity	Centres
	'X'	'Y'	Bar Mark	Grade and Size	Shape	P	A	B	C	E	F				
T4000	4000	1800	20A1	N20	A	-	3870	-	-	-	-	3870	7	130	
			12A2	N12	A	-	870	-	-	-	-	870	24	138	
			12H3	N12	H	60	1020	140	715	855	198	1933	4	-	
T3500	3500	1550	20A1	N20	A	-	3370	-	-	-	-	3370	7	130	
			12A2	N12	A	-	870	-	-	-	-	870	20	138	
			12H3	N12	H	60	900	140	715	855	198	1813	4	-	

NOTES:

- PRECAST PLANKS to be manufactured to MRTS72.
- DESIGN LOADING: This plank shall only be used for recreational boating situations. The maximum design load is for a dual axle trailer - 2 tonnes per axle at 750 centres.
- CONCRETE to be in accordance with MRTS70. Concrete to be S50/20, exposure classification C.
- REINFORCING STEEL to be in accordance with AS/NZS 4671 and MRTS71. Deformed bars Grade D500N. Minimum cover to reinforcing steel shall be 65 unless shown otherwise. All carbon reinforcing steel to be Australian Certification Authority for Reinforcing Steel (ACRS) certified. All carbon steel reinforcing bars, reinforcing mesh and tiewire shall be hot dip galvanised to AS/NZS 4680.
- STAINLESS STEEL to be in accordance with ASTM A276. Stainless Steel flat bar Grade 316. All work shall be neatly finished with sharp edges removed.
- TRAFFICABLE SURFACE FINISH: The aggregate shall be lightly or medium exposed and level with or slightly above the concrete matrix to achieve a non-slip finish.
- MASS of T4000 Precast Plank is 1650 kg. MASS of T3500 Precast Plank is 1450 kg. The mass of the plank shall be clearly and permanently marked on a side surface.
- M12 AND M20 FERRULES shall be stainless steel Grade 316 Elephant Foot Ferrules with the following capacities:

Ferrule	Length	Minimum Working Load Limit
M12	55mm	(Tension) 10.8kN (Shear) 12.1kN for concrete strength of 40MPa
M20	95mm	(Tension) 26.6kN for concrete strength of 32MPa

Cross bars (if required to achieve the minimum strength requirement) shall be stainless steel Grade 316. The manufacturer shall seek approval for the proposed ferrules in accordance with Clause 5.6 of MRTS72.
- LIFTING, TRANSPORTATION AND STORAGE shall be in accordance with MRTS72. Planks shall not be moved before attaining a minimum strength of 32 MPa.
- DIMENSIONS are in millimetres unless shown otherwise.

REFERENCED DOCUMENTS:

- Departmental Specifications:
- MRTS70 Concrete
 - MRTS71 Reinforcing Steel
 - MRTS71A Stainless Steel Reinforcing
 - MRTS72 Manufacture of Precast Elements
- Australian and International Standards:
- AS/NZS 1594 Hot Rolled Steel Flat Products
 - AS/NZS 3678 Structural Steel - Hot-rolled Plates, Floor Plates and Slabs
 - AS/NZS 4671 Steel Reinforcing Materials
 - AS/NZS 4680 Hot-dip Galvanized (Zinc) Coatings on Fabricated Ferrous Articles
 - ASTM A276 Standard Specification for Stainless Steel Bars and Shapes

Department of Transport and Main Roads					
PRECAST PLANKS FOR BOAT RAMP				© The State of Queensland (Department of Transport and Main Roads) 2016 http://creativecommons.org/licenses/by/3.0/au	
TYPES T4000 AND T3500		Standard Drawing No		4002	
Not to Scale		Date		10/16	
A		B			