

DETAIL 1
1651 SEEDING
SLOPE ≤ 1 ON 4

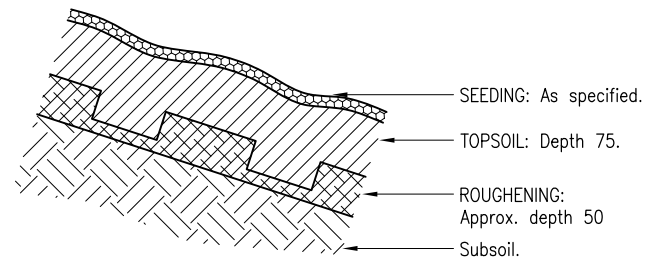

DETAIL 2
1651 SEEDING
SLOPE > 1 ON 4

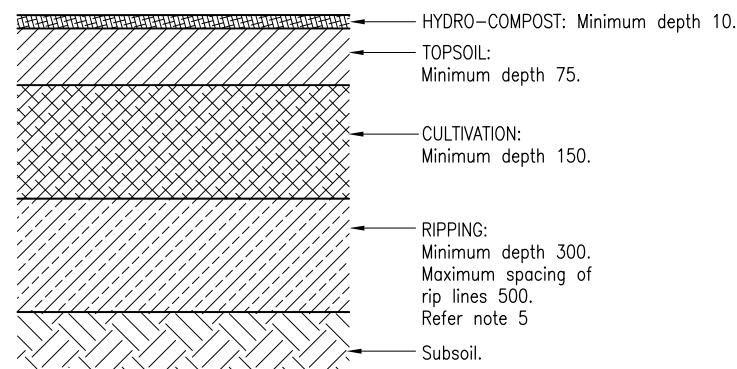

DETAIL 3
1651 HYDRO-COMPOST
SLOPE ≤ 1 ON 4

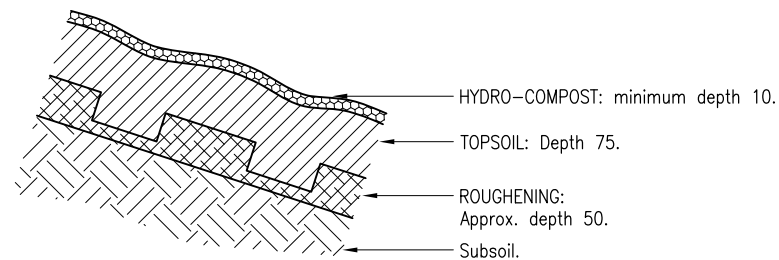

DETAIL 4
1651 HYDRO-COMPOST
SLOPE > 1 ON 4

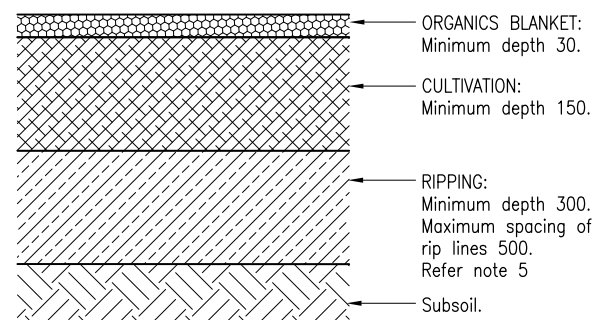

DETAIL 5
1651 ORGANICS BLANKET SEEDING
SLOPE ≤ 1 ON 4

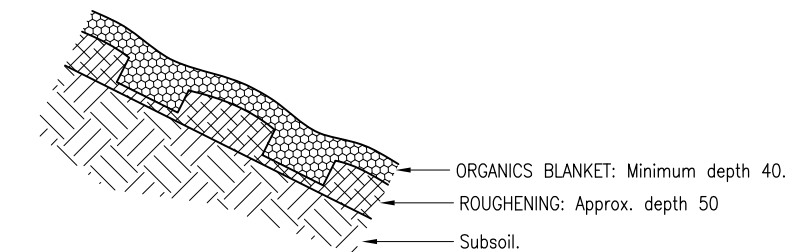

DETAIL 6
1651 ORGANICS BLANKET SEEDING
SLOPE > 1 ON 4

NOTES:

1. AMELIORATION: Where subsoil amelioration is required, ameliorants shall be applied to the surface prior to ground preparation operations (ripping, cultivation or roughening).
2. GROUND PREPARATION including ripping, cultivation and roughening shall be carried out parallel to the contours.
3. Treatments adjacent to hardstand areas shall be in accordance with Standard Drawing 1644.
4. ROUGHENING shall roughen and form keys in the subsoil to prevent subsequent material slipping down the face of the slope.
5. RIPPING is required only where ground has been:
 - previously compacted; or
 - used by vehicular traffic.
 - ie. decommissioned site compounds, building pads, parking areas, stock pile areas, roads and haul routes
6. RIPPING shall shatter compacted subsoil sufficiently to allow the subsequent cultivation operation.
7. CULTIVATION shall break up the surface of the subsoil sufficiently to produce a finely tilled material.
8. GROUND PREPARATION: Non-conforming stone, rubble and other deleterious material brought to the surface during ground preparation operations, shall be removed.
9. TOPSOIL: Depths are minimum depths after settlement has occurred. Allowance shall be made for settlement during installation.
10. SEEDING: Drill seeding, broadcast seeding, hydromulching and straw mulching.
11. SEEDING must be accordance with design constraints (clearzone, sight visibility, and other vegetation setbacks and clearances);
 - as shown on the Drawings; or
 - in the Road Landscape Manual - Appendix 4, where not shown on the Drawings.
12. SIGHT VISIBILITY AREAS within areas to be grass shall be turfed and not grass seeded.
13. DIMENSIONS are in millimetres unless shown otherwise.

ASSOCIATED DEPARTMENTAL DOCUMENTS:



- Standard Drawings
- Specifications
- Road Landscape Manual

REFERENCED DOCUMENTS:

- Departmental Standard Drawings: 1644 Vegetation Ground Works - Hardstand Abutments to Vegetation Works

Departmental Specifications:

- MRTS16 Landscape and Revegetation Works

| | | | |
|--|--------------|--|---|
| Department of Transport and Main Roads | |  <small>© The State of Queensland (Department of Transport and Main Roads) 2017 http://creativecommons.org/licenses/by/3.0/au</small> |  |
| VEGETATION WORKS | | | |
| SEEDING | A3 | Standard Drawing No | |
| | Not to Scale | 1651 | |
| | | Date 7/17 | |
| | A | B | E |